



AIR CANNONS

VIBCO

<http://www.VIBCO.com>

VIBCO'S AIR

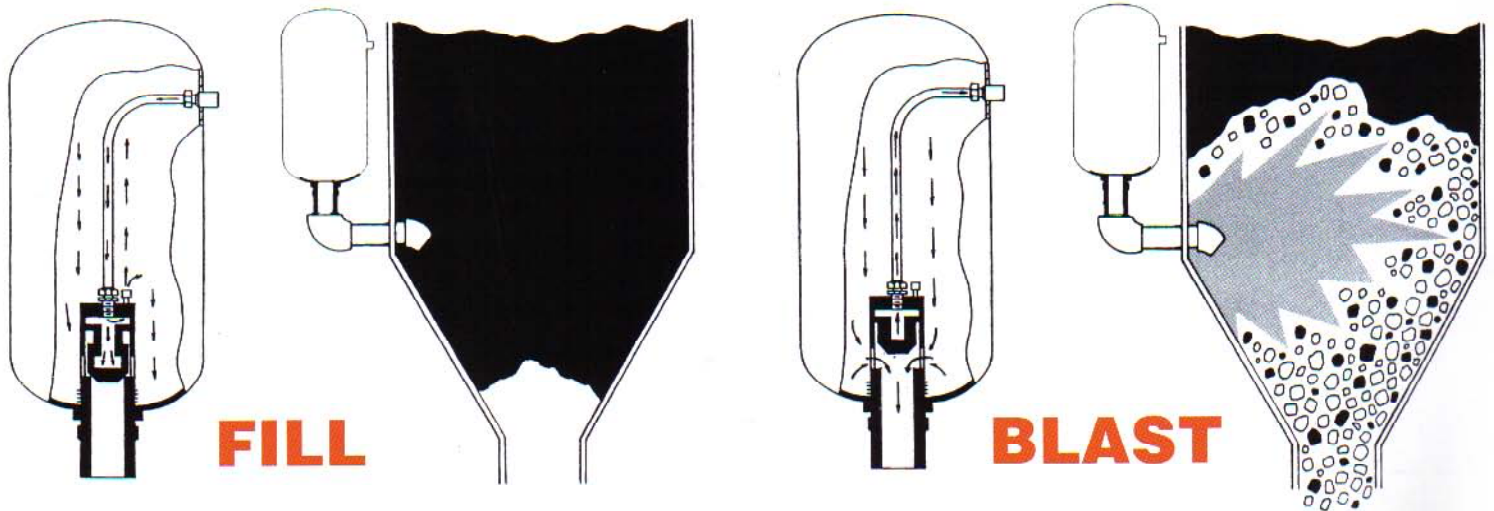

- **NEW** REVOLUTIONARY DESIGN
- NO CLOGGING OR STICKING VALVE
- MAINTENANCE FREE • SAFE • NOISELESS

VIBCO'S AIR CANNON uses a new double piston valve concept to solve material flow problems.

The **VIBCO AIR CANNON** will work safely and efficiently on normal plant air. 80 to 125 PSI is all that is required. No auxiliary compressors needed to provide high pressure, high volume air.

The **VIBCO AIR CANNON** is so simple that it has only one moving part.

The **VIBCO AIR CANNON** will work safely and efficiently in any position, on any bin - thick concrete or light gauge steel - on any material from wood chips, pellets, chemicals, clay cattle feed, stringy materials and many others.

HISTORY

VIBCO ELIMINATES "BACKLASH" In the 1970's VIBCO introduced it's "piston" design air cannon which proved to have many problems; in cold weather the piston froze to the side of the cylinder, in hot weather it swelled and got stuck. The O-rings on the piston dried up and caused seepage. The backlash caused material to enter the blast tube and blocked the piston. (BACKLASH: when the air shot out of the air cannon, it left a vacuum behind it causing a back suction or "backlash" sucking in material from the bin).

While other competitors remained with this piston design, VIBCO's engineers developed the "Ball Valve" design with a free flowing ball. This design was a great improvement over the piston design, no more "backlash" because the free flowing ball, due to gravity, would close off the discharge before a vacuum occurred. No dried up O-rings, no freezing or swelling.

However, there was another problem. If the air is contaminated or has an excess of water, the contamination could wedge between the ball and the wall and seize the ball. To eliminate this last problem, VIBCO came up with the **"DOUBLE PISTON"** design, with a free flowing piston like the ball, eliminating the "backlash". No air contamination can cause a hang up, it is contained in the piston cavity. The piston valve is not in contact with the steel cylinder and is unaffected by temperature changes. This new patent pending design finally will give you the same user confidence as VIBCO's other equipment is so well known for.

CANNON

prevents material sticking to bin walls . . .

HOW IT WORKS

The **VIBCO AIR CANNON** or **AIR BLASTER** consists of a high pressure tank storing compressed air (80-125 PSI) and a quick release piston valve which instantaneously on command releases the compressed air into the bin or silo.

It is the new and simple double piston design that makes the big difference when compared to other air blasters using a close tolerance piston with O-rings as a valve. The pistons in these swell and stick due to atmospheric change. After the blast the backlash may suck some of the bin material into the valve which also can cause the piston to stick. The O-rings due to lack of lubrication, can also stick or dry out, losing their sealing capability.

The **VIBCO DOUBLE PISTON** has a double piston that fits loosely in the cylinder - no tight tolerance fit. The air pressure behind the piston forces it against the valve seat where it attains a perfect seal. No O-rings are needed. It cannot jam, clog or stick, even if foreign material enters the valve. Picture shows air entering the cylinder through the hose, passing thru the check valve into the cylinder. The piston is pressed against its seat, forming an air tight seal.

The picture on the right illustrates the "Blast." When the three-way valve (manual or solenoid) is activated, the high pressure air in the filling line is released to atmosphere. The piston is both sucked away from its seat by the sudden pressure drop as well as pushed back by the high air pressure in the tank. This allows the high pressure air in the tank to "Blast" out through the discharge pipe into the material, breaking it loose. When the pressure in the tank has been released, the piston (due to force of gravity) falls down closing the outlet preventing a "backlash" and bin material from entering the valve and tank.

FACTS YOU SHOULD KNOW ABOUT VIBCO'S AIR CANNON

VIBCO's AIR CANNON creates no flames or sparks.

VIBCO's AIR CANNON can be blasted when needed up to every few seconds.

VIBCO's AIR CANNON needs no special compressor, uses regular plant air at 80-125 PSI.

VIBCO's AIR CANNON tank is certified to conform to "UNFIRED PRESSURE VESSELS" code.

VIBCO's AIR CANNON is inexpensive compared to other dischargers, such as High Pressure Blast systems, Air Pads, Vibrating Bin Bottoms.

VIBCO's AIR CANNON mounting is simple.

No structures need reinforcements. The air blast does not shake the structure, only the material.

VIBCO's AIR CANNON is economical, takes but 1/25 of energy used by air pads or other systems.

VIBCO's AIR CANNON is silent despite its name - all force and the air bang, like a back-firing truck, is absorbed by the material in the bin, which acts as a muffler, and the only sound heard is a mild "puff". Way below the OSHA requirements.

VIBCO'S AIR CANNON WILL SOLVE YOUR FLOW PROBLEM

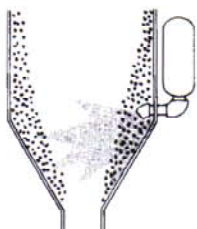

STICKING TO THE SIDES
a common flow problem.

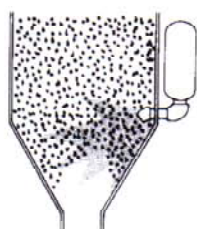

BRIDGING material
hanging at lower slope.

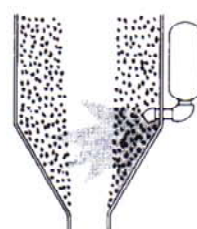

RATHOLING or dead
storage.

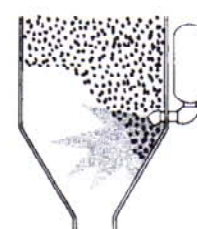

ARCHING at end or above
sloping section.

HOW TO SELECT

There are two methods of selecting Air Cannons for your application.

METHOD 1. Select for bin size. As a general rule, if the diameter of the bin is:

- 2 to 6 feet diameter or side, use **ABS 1-1/2**.
- 6 to 10 feet diameter, use **ABS-2**.
- 10 to 15 feet use **ABS 4-2**, one for every 13-15 feet of circumference or perimeter.
- 16 to 20 feet use **ABS 4-5**, one for every 20-25 feet of circumference or perimeter.
- 21 to 26 feet use **ABS 4-10**, one for every 25-30 feet of circumference or perimeter.

NOTE: If conditions permit, a larger air cannon can be used on a smaller bin than recommended. For example, 15' bin, two model ABS 4-5 can be used and placed 20-25' apart instead of three model ABS 2 placed 13-15' apart.

For materials with densities less than 35 lbs/cu. ft. - use 50% more air cannons than indicated above. If the size of the material discharge opening is so small that it holds back the free flow of material loosened by the air cannon, the installation of a small vibrator will be required. By placing a vibrator at the bottleneck "flow friction" will be reduced and the desired discharge rate can be maintained.

The impact range of the vibrator only needs to be 1/4 of the impact normally used when no air cannons are used or one lb. of impact will move 40 lbs. of material collected in the sloping part of the bin.

METHOD 2. Select for material and area of influence.

This method is used for tough materials and odd shaped bins. The rules are very simple. First, determine the area to be blasted (material hang-up area). Second, according to table, determine material group A or B. By following the table, the area of blast influence is determined. Now lay out area of influence in the area to be blasted. Make the area of influence overlap in critical areas.

Material Type A: Large chunks, high moisture content; clings to walls; will set up or harden when stored; weight in excess of 65-70 lbs. per cu. ft., or slope angles less than 30° with small discharge openings.

Material Type B: Dry, powdery, stringy or spongy, with material weight less than 60 lbs. per cu. ft., slope angles more than 45° and large discharge openings.

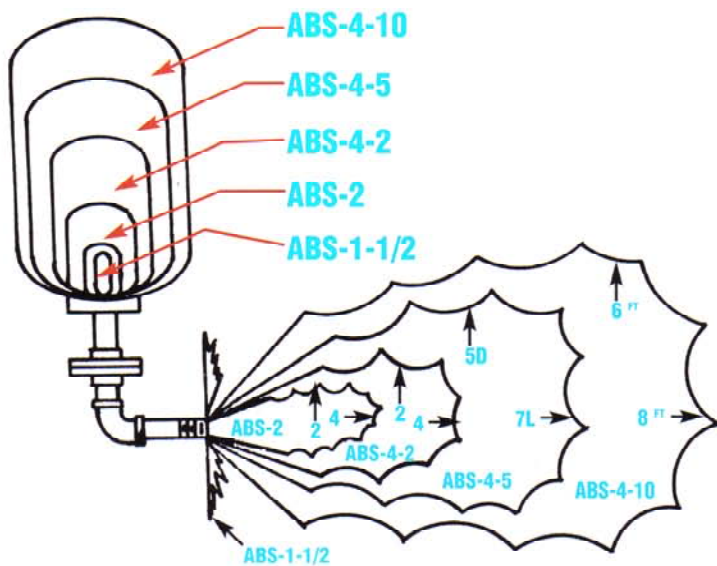

Model No.	Material A Blast Span L' x D'	Material B Blast Span L' x D'
ABS-1-1/2	3 x 1	4 x 2
ABS -2	4 x 2	7 x 3
ABS-4-2	6 x 4	9 x 5
ABS-4-5	7 x 5	10 x 6
ABS-4-10	8 x 6	12 x 7

TECHNICAL DATA - ALL BLASTERS

Model No.	Volume Cu. Ft	Free Air 80 PSI Cu. Ft.	Length Inches	Diameter Inches	Discharge Size
ABS-1-1/2	.11	.6	24	5-1/2	1-1/2 NPT
ABS-2	.6	3.26	15	10	2 NPT
ABS-4-2	1.36	7.40	24	12	4 NPT
ABS-4-5	4.35	23.67	42	16	4 NPT
ABS-4-10	9.33	50.78	44	24	4 NPT

VIBCO'S AIR SWEEPER SYSTEM

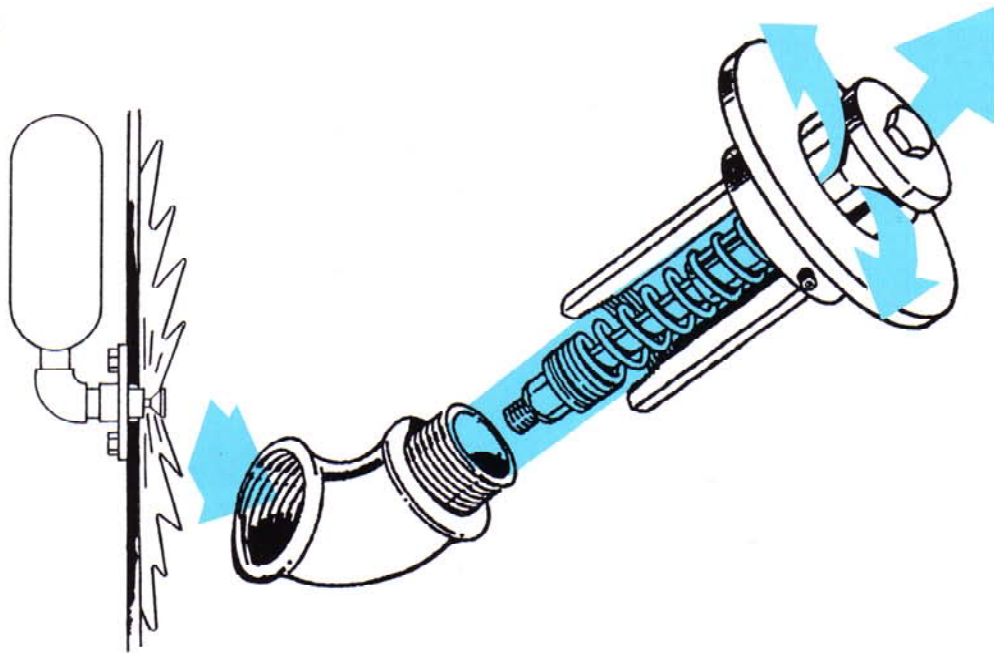

WHAT IS AN AIRSWEEP?

The airsweep system consists of a spring loaded piston valve that instantaneously upon command, opens and releases compressed air in an up to 8' circle sweeping the bin side. The air blast reduces the friction between the bin material and the bin wall to prevent bridging, ratholing, packing and clinging of material to the walls. After firing, valve closes and seals off the discharge opening preventing material from entering, making it possible to use the bin for multiple material charges without contamination.

The sweeper valve can operate in temperatures up to 900° and be supplied in carbon or stainless steel. Two systems are available:

SYSTEM 1

The Sweeper Valve is added to ABS-2, and ABS-1-1/2 blasters to deflect the blast along the side of the bin to break the bond and friction between the material and bin wall. The Sweeper Valve is especially suitable when material bridges close to the discharge due to flow obstructions, such as rotary valves, chutes, or feed pipes, or discharge openings.

SYSTEM 2

Consists of strategically located air sweep valves, solenoids, air receiver tank and timer. The timer is programmed to pulse blast small amounts of high velocity air along the bin wall reaching up to 8' diameter, dislodging, aerating, and moving the material towards the discharge opening. This system produces more positive results than air pads without clogging and with a higher air velocity and better aeration that also sweeps the side of the bin removing material sticking to the bin side, allowing multiple materials charges without contamination. Two sizes available, ASP-75-3/4 NPT and ASP-150-1-1/2 NPT. Ideal to use on smaller bins made of fiberglass, wood, downspouts, pipe and chutes, etc.

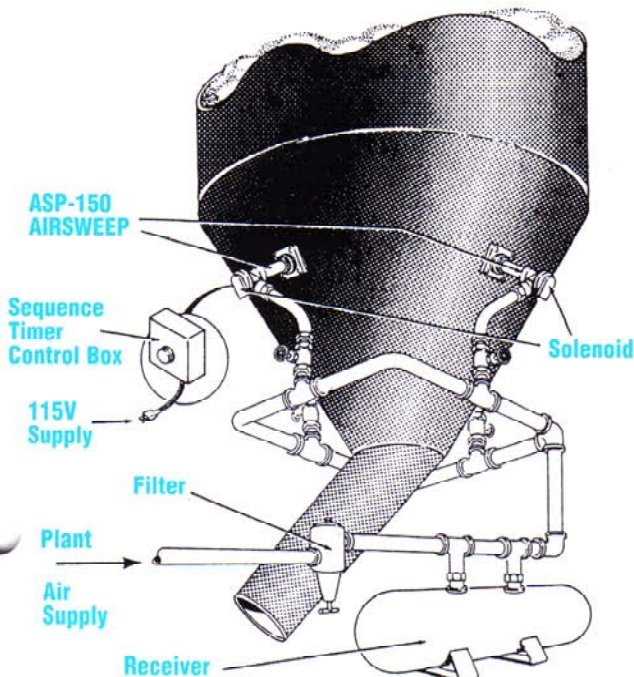

TECHNICAL DATA - SWEEPER VALVE

Model No.	Discharge Size NPT	Air Pressure PSI	Sweep-Span Feet	Air Usage CF*
ASP-75	3/4	40	2	.3
		60	3	.5
ASP-150	1-1/2	80	6	1.8
		90	8	2.4

*For System 2. For System 1 see Air Cannon Volume Cu. Ft.

HOW TO INSTALL AVAILABLE ACCESSORIES

MOUNTING ACCESSORIES

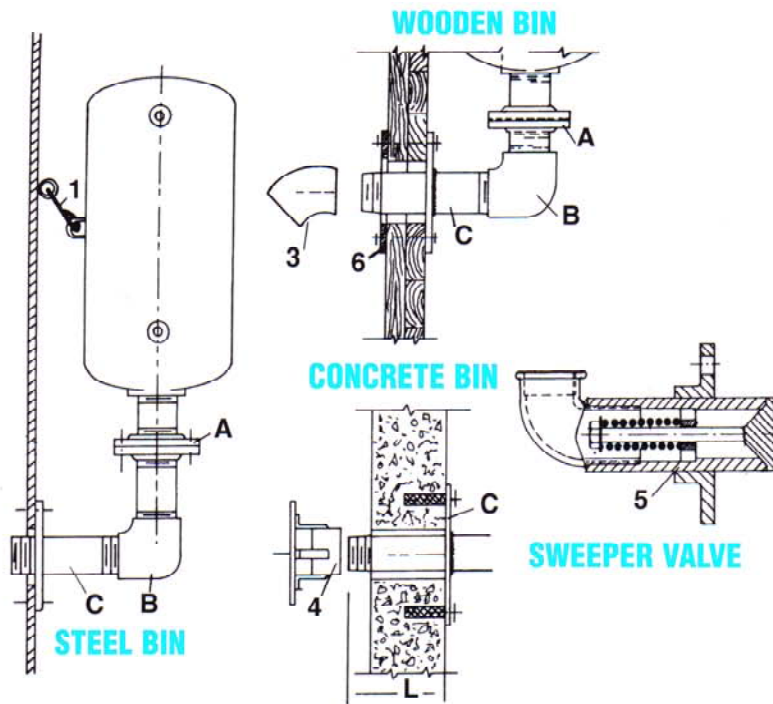

All Air Cannons come complete with 3-way, 110/120 volt, 50/60 Hz Solenoid Valve and Quick Exhaust Valve. ABS-2 and ABS-4 Air Cannons also come with Safety Relief Valves.

1. Safety Cable
2. Mounting Kit, consisting of:
 - A.) Set of Companion Flanges w/Bolts
 - B.) 90° Street Elbow
 - C.) Mounting Flange (Note: Mounting flange comes standard with "L" dimension of 2-1/2". Please specify with order if longer dimensions required.)
3. Directional Elbow (45° or 90°)
4. Diffuser
5. Sweeper Valve (ABS-1-1/2 & ABS-2)
6. Back-up plate for wooden bin

CONTROLS

The complete installation is done easily and quickly. Once the trouble area is determined, a hole is cut in the structure one inch larger than the release pipe of the air cannon. The mounting flange is then welded or bolted to the bin side over the hole. The cylinder is attached to the release pipe and the air and operating connections are made. The operation can either be made manually or automatically. The manual incorporates either a simple air release valve or a solenoid with an electric switch. The automatic operation consists of a solenoid valve and timer. Once installed, the cycle time can be changed from once a day or when necessary, to be as fast as the cylinder can be filled with air. Ask for special bulletin #8203.

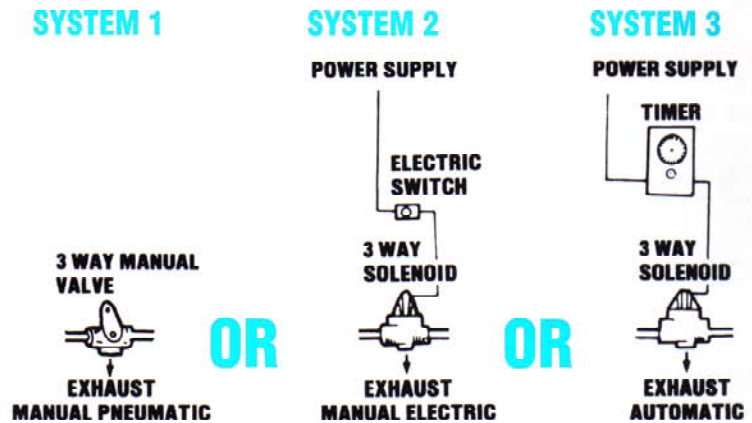

VIBCO'S DOUBLE PISTON VALVE AVAILABLE FOR MOST AIR CANNONS

Vibco's maintenance free double piston valve fits most competitors' air cannons. They are easily retrofitted into Style 1 and Style 2. For other styles contact our Engineering Department.

HOW TO ORDER: Either give original manufacturer's model or just Style 1 or Style 2. Give the diameter D and length L.

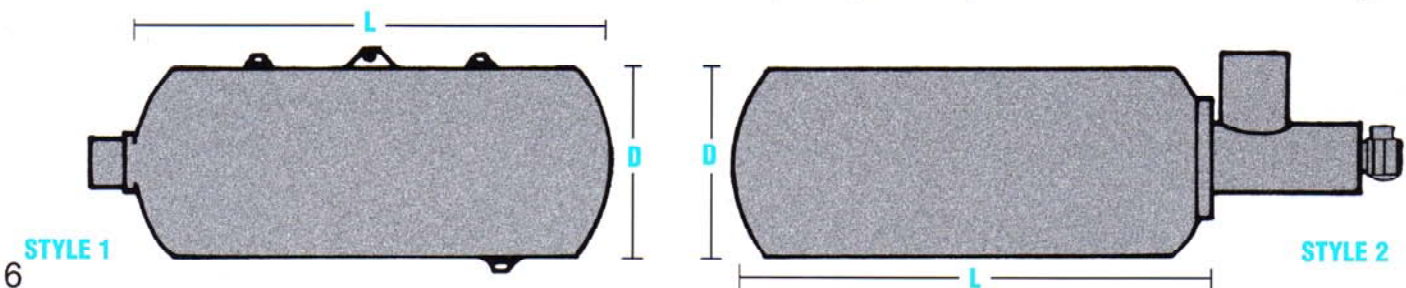

VIBCO'S AIR CANNONS ON THE JOB

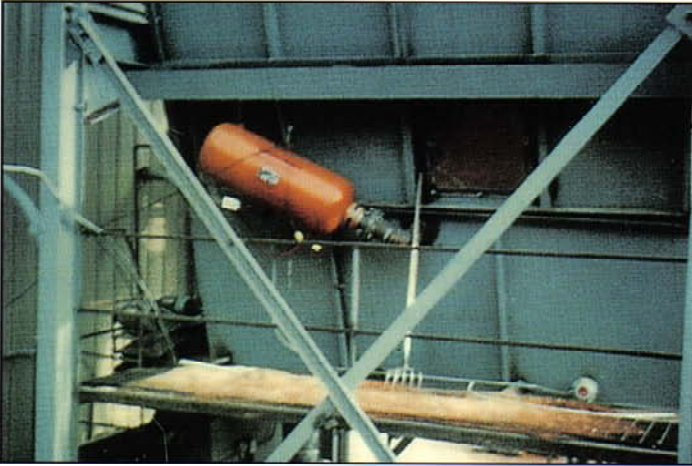

TWO ABS-4-5 AIR CANNONS ON FEED BIN:

Company used cannons to maintain a continuous feed of bark and wood chips to fire boiler. No bridging or packing over screw conveyors occurred.

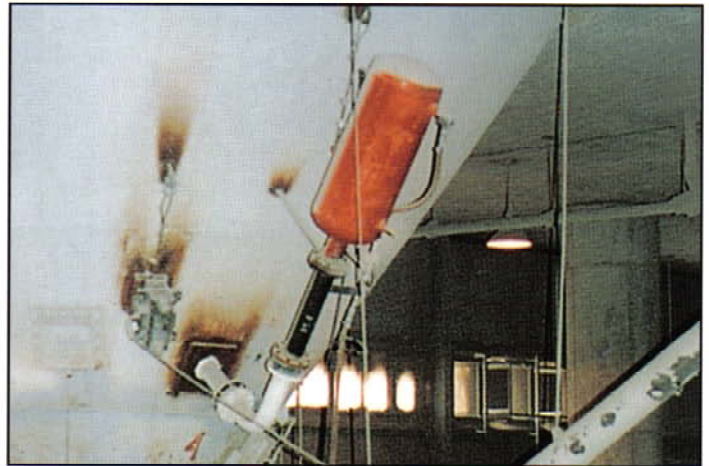

ABS-4-5 AIR CANNON ON CEMENT SILO:

Long pipe was used to eliminate aerated cement from backing up in discharge pipe.

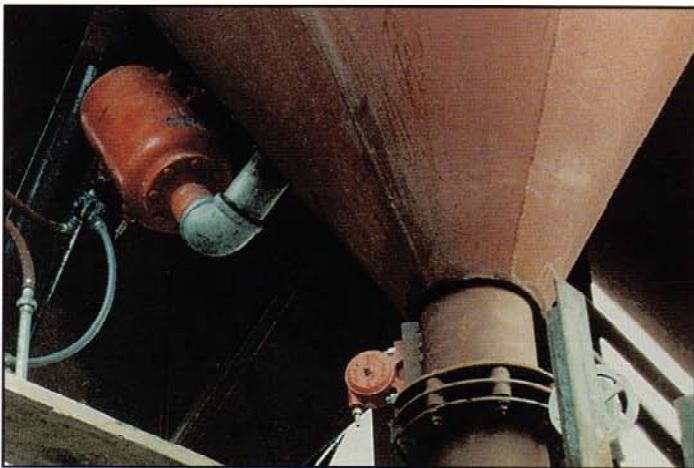

AIR CANNON & AIR VIBRATOR COMBO:

Air Cannon moves material to feed chute where VS-320 air turbine keeps material moving.

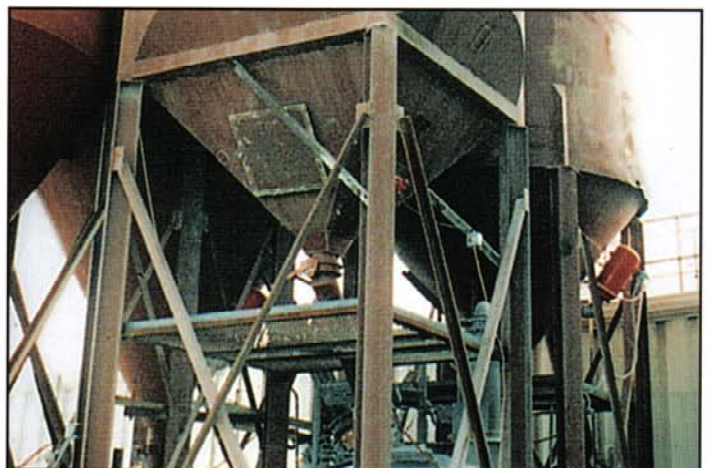

ABS-4-2 ON WHEAT GLUTEN BIN: Material would cake up making discharge impossible. Continuous aeration eliminated this problem



HOGGED FUEL BIN HAS 4 ABS-4-5: Lumber company installed air cannons to move the hogged fuel to the internal agitators reducing boiler down time.



ABS-2 ON CEMENT HOPPER: Continuous blasting kept cement aerated and free flowing.

VIBCO'S AIR CANNONS ON THE JOB

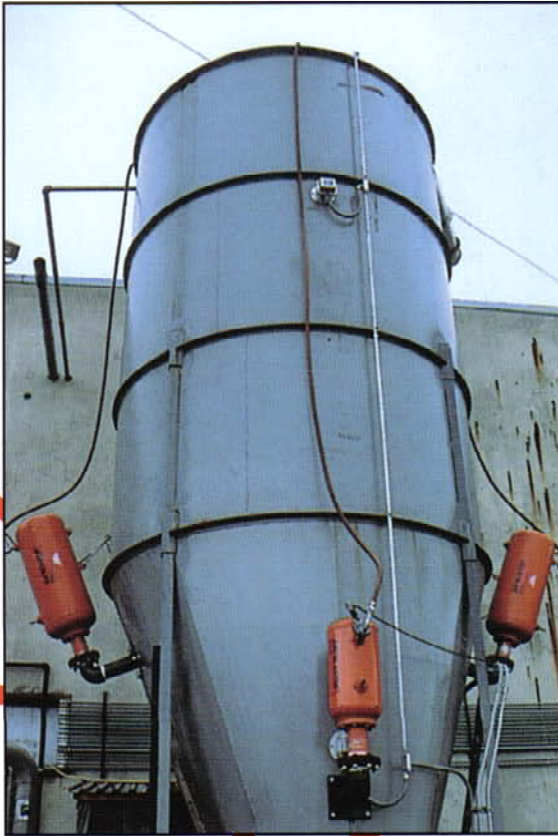

CO-GENERATION PLANT: Use ABS-4-5 blasters to feed cut-up paper bags to furnace. Ask for Bulletin 9065.



HIGH TEMPERATURE BIN: Recycling bin with 300°F temperature use ABS-4-10's. Long discharge pipes eliminate heat problem. Ask for Bulletin 9060.

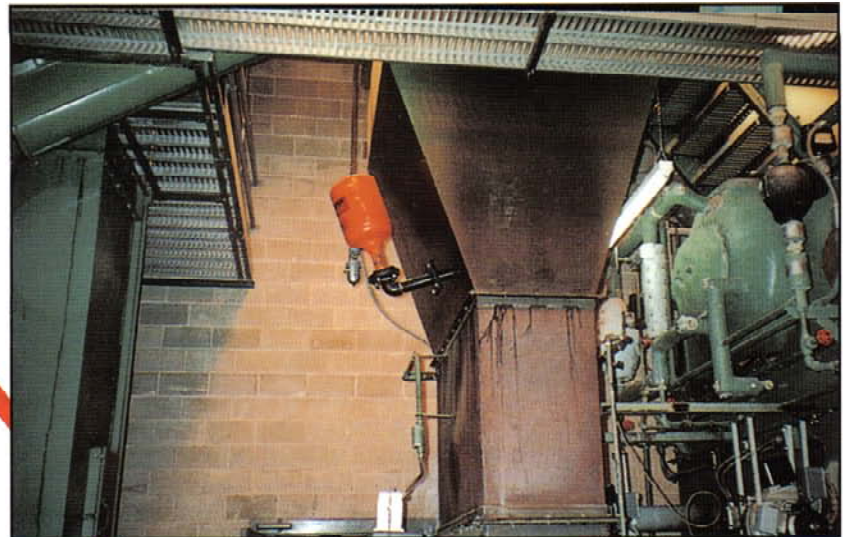
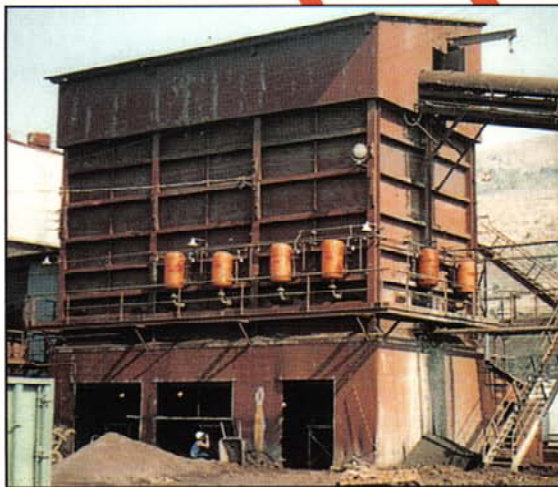

ABS-2 KEEPS WOOD CHIPS FLOWING: Air cannon was placed just above stacker chute to keep it clean and wood chips flowing. Ask for Bulletin 9124.

ABS-4-10's ON ZINC BUNKER: Ground zinc dust collected in bunker and fed into factory for processing. Ask for Bulletin 9070.

We're The **SILENT** Vibrator Guys.®



CONTACT OUR ENGINEERING DEPARTMENT FOR RECOMMENDATIONS.

VIBCO, INC.

75 Stilson Road, P.O. Box 8
Wyoming, RI 02898
E-Mail: vibrators@vibco.com
Phone: (401) 539-2392 / (800) 633-0032
FAX: (401) 539-2584
<http://www.VIBCO.com>

West Coast:
Phoenix, Arizona 85254
Phone: (480) 596-1809
(800) 633-0032
FAX: (480) 596-1614

Canada:
2215 Dunwin Drive
Mississauga, Ont.L5L 1X1
Phone: (905) 828-4191
(800) 465-9709
FAX: (905) 828-5015

SEE US AT www.VIBCO.com

#9131B
©2001 VIBCO, INC.